



**NSTX**

## **Turbo Pump Magnetic Shielding Analysis**

NSTX-CALC-24-04-00

March 16, 2011

Prepared By:

---

Yuhu Zhai, PPPL Mechanical Engineering  
Reviewed By:

---

Ali Zolfaghari, PPPL Analysis Division  
Reviewed By:

---

Bill Blanchard, Cognizant Engineer

**PPPL Calculation Form**

Calculation # **NSTXU-CALC-24-00** Revision # **00** WP #, if any **1511**  
(ENG-032)

Purpose of Calculation: (Define why the calculation is being performed.)

To perform 3D analysis for the design of magnetic shield for the NSTX vacuum turbo pump to reduce the fringe field from NSTX coils at the pump location to below 50 gauss; and to extract Lorentz forces on the magnetic shield to ensure the shield is adequately supported

References (List any source of design information including computer program titles and revision levels.)

Calculated Poloidal Magnetic Quantities for the May 4, 2010 Design of the NSTX CS Upgrade, R. Woolley, Memo 13-171210-RDW-01, 17 December, 2010

Parametric Magnetic Shielding Analysis, L. Bryant on Magnetic Shielding Preliminary Study, PPPL Presentation, 2010

Assumptions (Identify all assumptions made as part of this calculation.)

Hysteresis effect of low carbon steel is small  
Fringe field from plasma is neglected to be conservative

Calculation (Calculation is either documented here or attached)

- 1. Fringe fields from NSTX coils (TF, PF, OH) without shielding
- 2. Fringe fields with magnetic shielding (half inch thick cylinder)
- 3. Lorentz forces on the magnetic shield

Conclusion (Specify whether or not the purpose of the calculation was accomplished.)

The results for the half inch thick cylindrical shield show that: 1) the maximum field in the shield is ~1.5 T, which is below the saturation value for the M19 steel; 2) the fringe field inside shield is below 50 G and overall Lorentz force on the pump is below 50 pound. 3) Although the magnetic field with shielding at the mid-plane inside the shield is below 20 gauss, the shield, however, needs to be at least 12 inches longer than the pump (6 inches above the top and below the bottom of the turbo pump) for the fringe field to be within 50 gauss at the pump top and bottom of the pump.

The total weight of the shield is ~100 kg (220 lbs).

Cognizant Engineer’s printed name, signature, and date:

\_\_\_\_\_

**I have reviewed this calculation and, to my professional satisfaction, it is properly performed and correct.**

Checker’s printed name, signature, and date:

\_\_\_\_\_

## Executive Summary

The objectives of this analysis for the NSTX Upgrade turbo pump magnetic shielding were: 1) to design magnetic shield using low carbon steels to reduce the maximum fringe field from NSTX coils at the turbo pump location (initially 3.5 m away from NSTX and ~3.45 m below the NSTX mid-plane but later on moved 20 inches further down the mid-plane to be closer to ground) to below 50 gauss on the pump within the shield. Specifically, NSTX coils generate about 350 gauss fringe field at the initial pump location (3.5 m in radial direction and 3.45 m down the NSTX mid-plane) where the fringe field consists of ~300 gauss radial field, 110 gauss vertical field and 145 gauss toroidal field; and 2) to extract Lorentz forces on the magnetic shield to ensure the shield is adequately supported.

OPERA and Maxwell 3d magnetic shielding models with current carrying conductors such as PF, OH inner TF and outer TF coils are developed for the nonlinear magneto-static analysis using BH property of M19 steel. M19 is considered the most effective in preliminary 2D analysis by L. Bryant. The NSTX coil magnetic fields from 3d models are benchmarked against the Design Point Spreadsheets and the Woolley Design Sheet. The nonlinear 3d results are compared with previous ANSYS 2D analysis. The main advantage of OPERA 3d model over the Maxwell 3d model is that one can quickly extract fringe field distribution at the pump location for various current scenarios based on the Biot-Savart law even before running the nonlinear finite element model, which takes hours to run. Then, the current scenario generating the maximum fringe field is selected for the nonlinear analysis.

The fringe field from PF 4 and 5 are very much dominant and thus current scenarios #49 and #79 with the combined largest net negative current in these coils are investigated without plasma current to be conservative. The plasma current (in positive direction) will reduce the coil generated fringe fields.

The results for the half inch thick cylindrical shield show that: 1) the maximum field in the shield is ~1.5 T, which is below the saturation value for the M19 steel; 2) the fringe field inside shield is below 50 G and overall Lorentz force on the pump is below 50 pound. 3) Although the magnetic field with shielding at the mid-plane inside the shield is below 20 gauss, the shield, however, needs to be at least 12 inches longer than the pump (6 inches above the top and below the bottom of the turbo pump) for the fringe field to be within 50 gauss at the pump top and bottom of the pump.

The total volume of the cylindrical shield is 0.01228 m<sup>3</sup> and its weight is about 100 kg (220 lbs) for iron mass density of ~8000 kg/m<sup>3</sup>.

## Table of Contents

List of Figures.....	4
List of Tables.....	4
1.0 OPERA 3D Model and NSTX Coil Magnetic Fields .....	5
1.1 Magnetic Shielding 3D Model Description .....	9
2.0 Magnetic Material Properties in the 3D Models .....	9
2.1 Comparison of Magnetic Fields on the Shield for Initial Shield Location .....	10
2.2 Forces and Torques on the Shield for Initial Shield Location .....	12
2.3 OPERA Results for Moving Shield 20 Inches Further Down .....	12
2.4 Forces and Torques for Lowering Shield 20 Inches More below NSTX Mid-Plane .....	15
3.0 Summary and Conclusions .....	16
Reference(s).....	16

## List of Figures

Figure 1.0 - NSTX PF, OH and TF Coils; PF and OH Coils Only.....	5
Figure 1.1 - Comparison of Magnetic Fields (current scenario # 79).....	5
Figure 1.2 - Contour Plot of Magnetic Field in NSTX Mid-plane (from center).....	6
Figure 1.3 - Contour Plot of Magnetic Field in NSTX Mid-plane (around TF outer legs).....	6
Figure 1.4 - Comparison of Fields in Radial Direction (current scenario #79 – OPERA 3d).....	7
Figure 1.5 - Comparison of Fields in Vertical Direction (current scenario #79 – OPERA 3d).....	7
Figure 1.6 - Relative Error of Fields in Radial Direction (current scenario #79 – OPERA 3d).....	7
Figure 1.7 - Relative Error of Fields in Vertical Direction (current scenario #79 – OPERA 3d).....	8
Figure 1.8 - Maxwell 3d Magnetic Shielding Model .....	9
Figure 1.9 - OPERA 3d Magnetic Shielding Model (left) and Finite Element Mesh in Shield (right).....	9
Figure 2.0 - BH Curves for Various Soft Magnetic Materials .....	10
Figure 2.1 - Cartoon: Magnetization of the Shield .....	10
Figure 2.2 - Maxwell 3D: Magnetic Flux Density Distribution on the Shield .....	11
Figure 2.3 - OPERA 3D: Flux Density Distribution on the Shield with B Field Vector .....	11
Figure 2.4 - OPERA 3D: Flux Density Distribution on the Shield Lower 20 Inches More .....	12
Figure 2.5 - B Field along Radial Direction in Shield Mid-Plane .....	13
Figure 2.6 - B Field along Radial Direction in Shield Mid-Plane (inside shield) .....	13
Figure 2.7 - B Field along Toroidal Direction in Shield Mid-Plane .....	14
Figure 2.8 - B Field along Toroidal Direction in Shield Mid-Plane (inside shield).....	14
Figure 2.9 - B Field along Vertical Direction along Shield Vertical Axis .....	15
Figure 2.10- B Field around Hole inside the Shield .....	15

## List of Tables

Table 1.1 - OPERA 3D: Fringe Fields at Centers of Turbo Pump .....	8
Table 2.1 - Force and Torque on the Shield due to Magnetization .....	12
Table 2.2 - Force and Torque on the Shield (lower 20 inches more below NSTX mid-plane) .....	16

## 1.0 OPERA 3D Model and NSTX Coil Magnetic Fields

The NSTX PF, OH and TF coils in OPERA 3D model are shown in Figure 1.0. The small fringe fields of TF flex joints are neglected for the purpose of this magnetic shielding analysis. All TF, PF and OH coils are treated as Biot-Savart conductors in OPERA to extract magnetic field distribution of coils anywhere in 3D space without involving finite element analysis. The model with PF and OH coils only are shown in right of Figure 1.0 and it is used for benchmark the model against Woolley Design Sheet to ensure that the Opera model produces the same fringe fields as the Design Sheet.

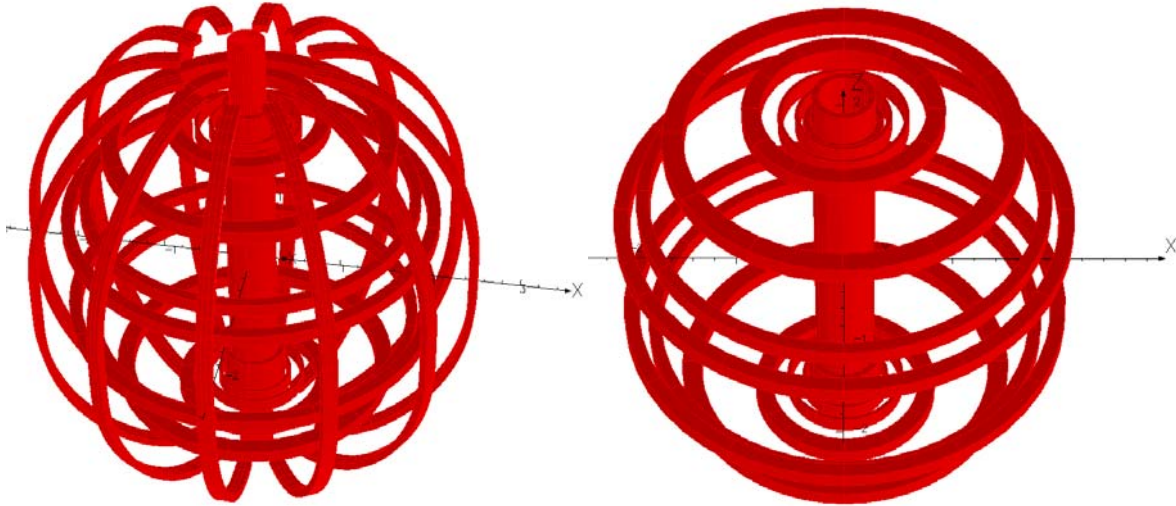

Figure 1.0 - NSTX PF, OH, TF coils (left); NSTX PF and OH coils only (right)

The NSTX coil magnetic fields (total field distribution from all coils – TF, PF and OH) in the vertical plane for current scenario #79 from OPERA 3D and Maxwell 3D are shown in Figure 1.1. Again, this is to validate the 3D Opera Model. Figures 1.2-1.3 present the magnetic field contours in the mid-plane of NSTX, where the ripple effects of the TF coils are clearly shown. The higher field flux contour shows larger TF ripple effect than the smaller field flux contour.

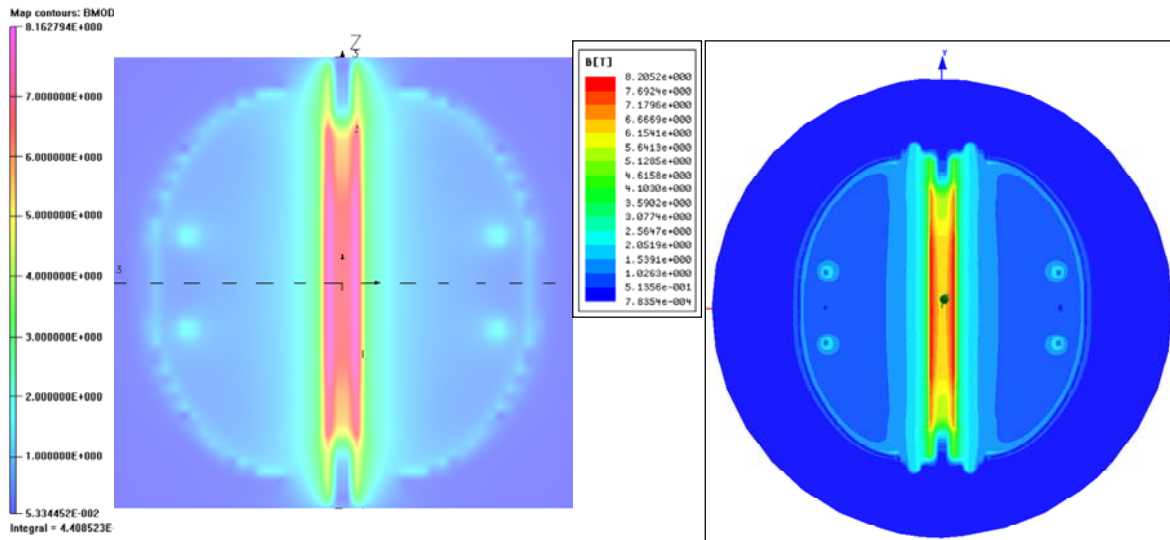

Figure 1.1 – Comparison of NSTX magnetic fields (total field distribution for current scenario #79 – OPERA on left and Maxwell on right)

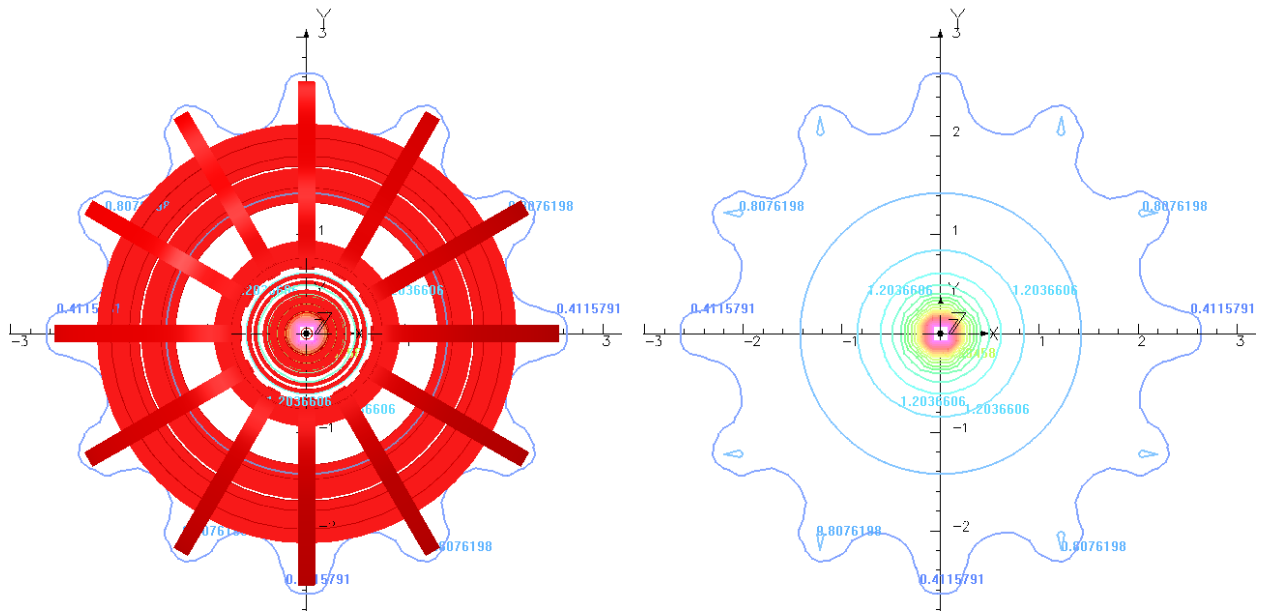

Figure 1.2 – Contour plot of NSTX mid-plane fields (from center at current scenario #79 – OPERA 3d in Tesla)

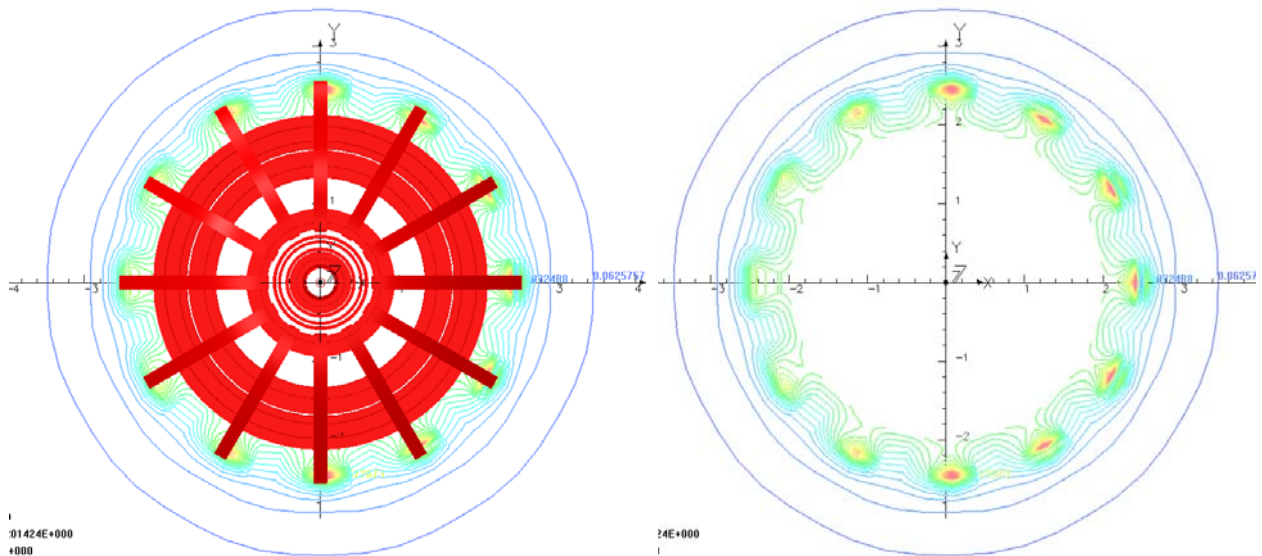

Figure 1.3 – Contour plot of NSTX mid-plane fields (around TF legs at current scenario #79 – OPERA 3d)

Figures 1.4-1.7 present comparison of PF and OH magnetic fields (Total field from PF and OH coils) for current scenario #79 from OPERA 3D and that from Woolley Design Sheet (with 10% headroom). The relative errors shown in figures are generally below 1%. The Woolley data, however, does not include the TF field. Comparison of field from all coils with Maxwell is shown in Figure 1.1.

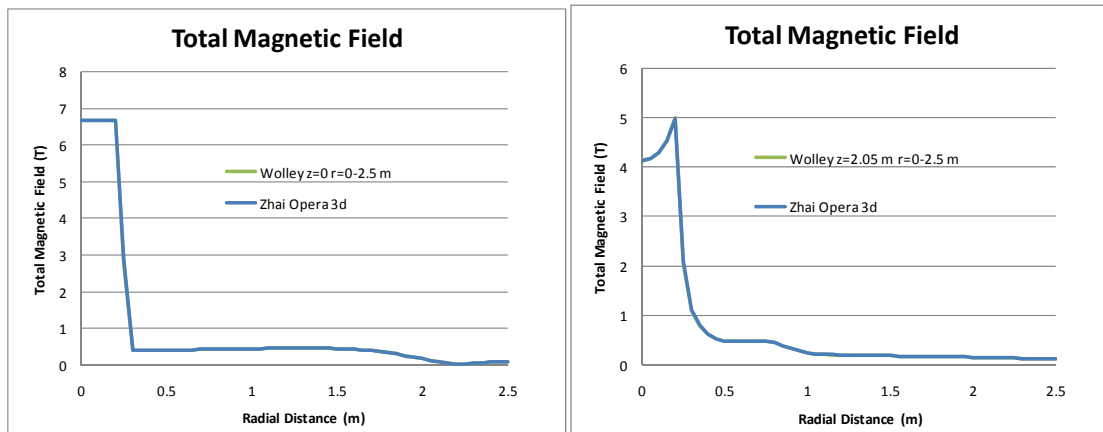

Figure 1.4 – Comparison of Fields in Radial Direction (current scenario #79 – OPERA 3d)

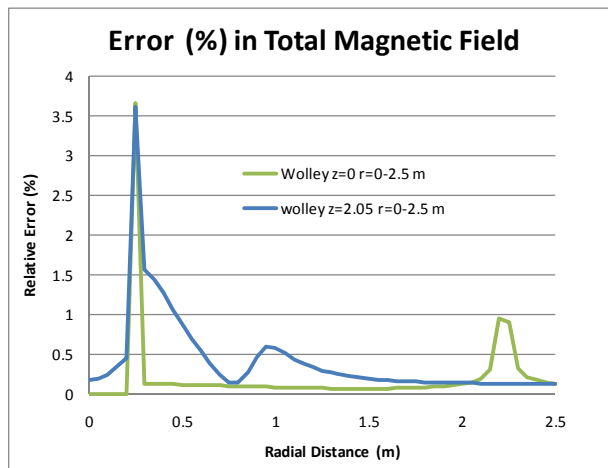

Figure 1.5 – Relative Error of Fields in Radial Direction (current scenario #79 – OPERA 3d)

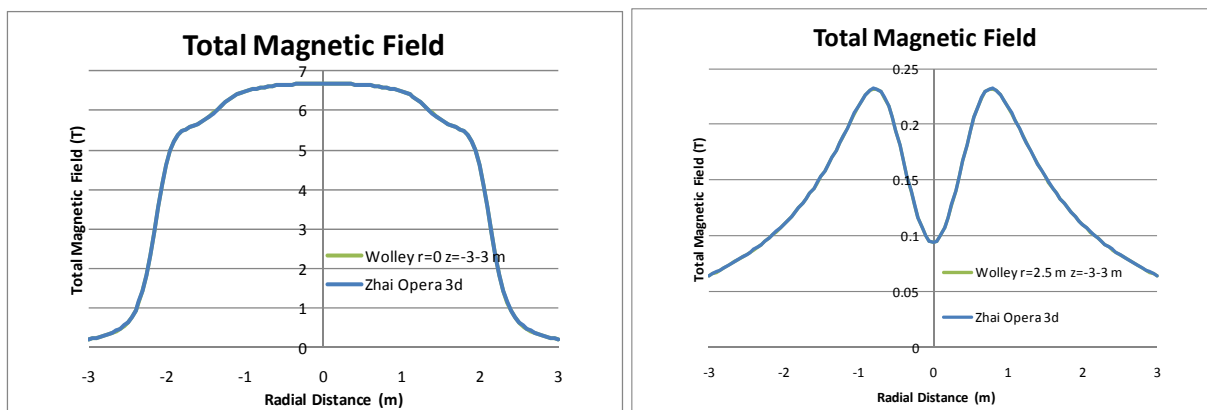

Figure 1.6 – Comparison of Fields in Vertical Direction (current scenario #79 – OPERA 3d)

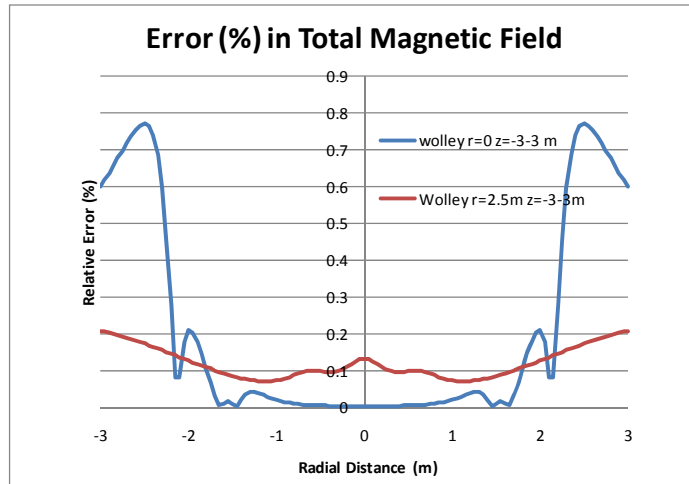

Figure 1.7 – Relative Error of Fields in Vertical Direction (current scenario #79 – OPERA 3d)

Several current scenarios are investigated using OPERA 3d postprocessor to extract the maximum fringe field and it was found that currents in PF 4 and 5 generate most of the fringe field and current scenario #79 seems to give the maximum field at pump location without shielding.

The NSTX coil fringe fields for scenario #79 without shielding at the pump center location are shown in Table 1.1. The pump is initially to be located at (3.5, 0, -3.45) m and later moved 20 inches more below NSTX mid-plane to (3.5, 0, -3.96) m. Since fringe field from the plasma current will cancel the dominant fringe field from PF5 coils, plasma current is neglected here to be conservative.

Table 1.1 – OPERA 3D: Fringe Fields at Centers of Turbo Pump

Fringe Field (G)	Radial	Toroidal	Vertical	Total
Initial pump center (G)	301.2	145.8	-108.8	351.9
Lower 20 inches more (G)	239.2	133.4	-118.2	300.0



## 1.1 Magnetic Shielding 3D Model Description

The Maxwell magnetic shielding model shown in Figure 1.8 is developed based on the Maxwell magneto-static model of NSTX coils developed by Tom Willard. The solid model geometry of the cylindrical shield 6 inch above and below the turbo pump is imported into Tom's Maxwell model and the air-block is increased from 4 m radius to 5.5 m radius to be not so close to shield.

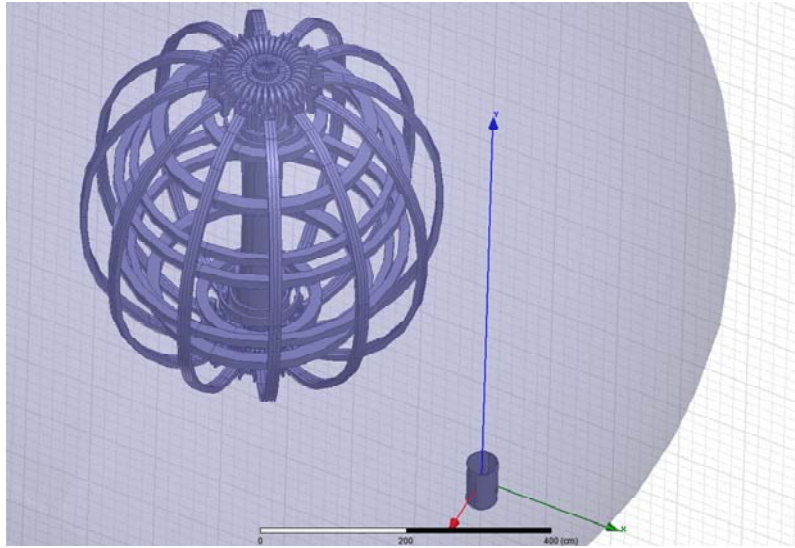

Figure 1.8 – Maxwell 3d Magnetic Shielding Model

The OPERA magnetic shielding model shown in Figure 1.9 is based on the OPERA NSTX coil conductors developed and described in previous section. The solid model geometry of the cylindrical shield 6 inch above and below the turbo pump is imported into Opera Modeler and the air-block is ~6 m in radius.

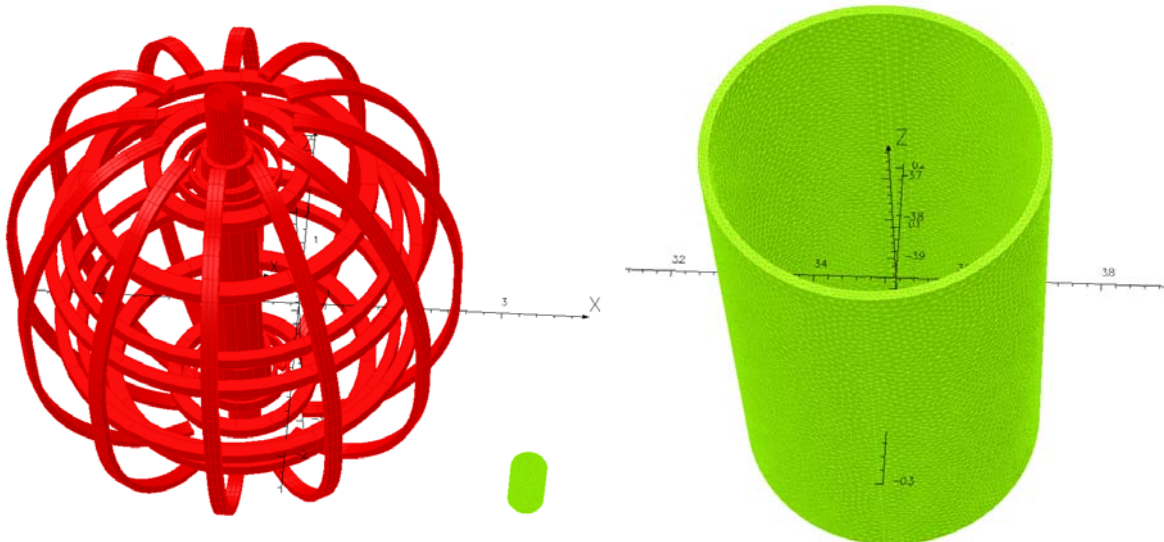

Figure 1.9 – OPERA 3d Magnetic Shielding Model (left) and Finite Element Mesh in Shield (right)

## 2.0 Magnetic Material Properties in the 3D Models

Figure 2.0 presents the BH curves for various soft magnetic materials for the magnetic shielding study. Hysteresis effect is neglected in current analysis. Previous 2D study by Bryant indicates that M-19 is the most efficient material for shielding and thus the 3D analysis uses M-19 only.

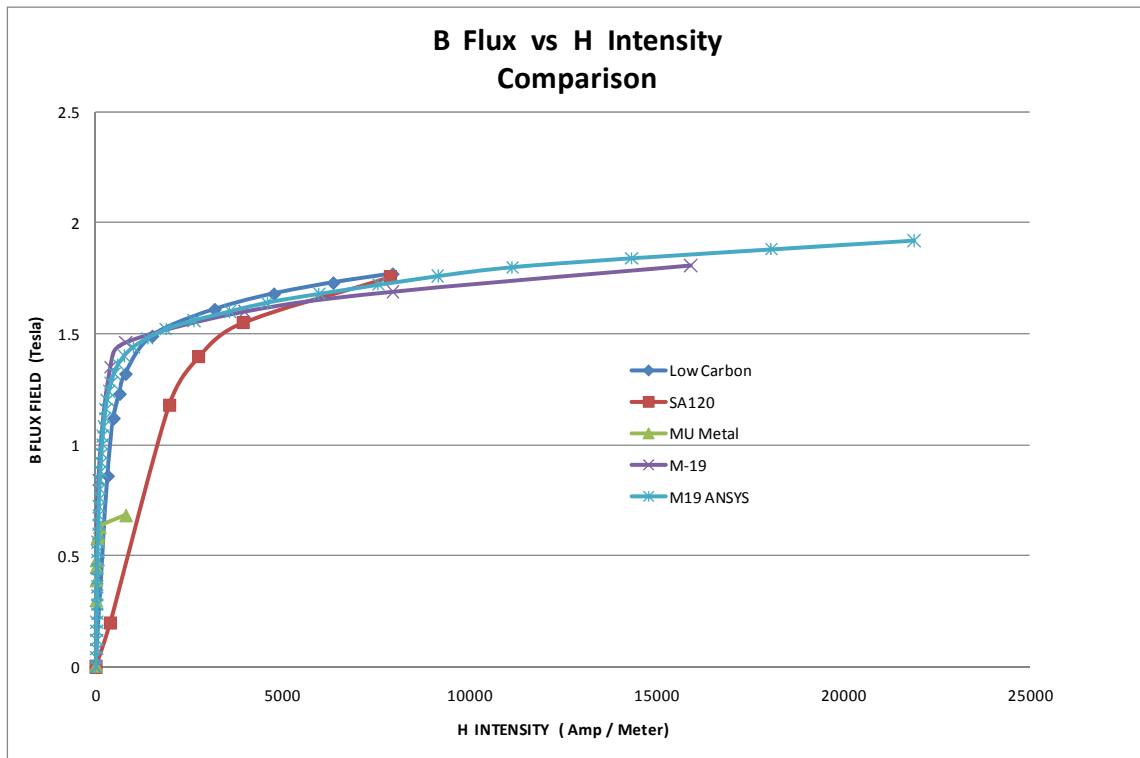

Figure 2.0 – BH Curves for Various Soft Magnetic Materials  
(M-19 is used in Bryant’s 2D study and M19-ANSYS from Mark Christini at ANSYS is used in the 3D models)

### 2.1 Comparison of Magnetic Fields on the Shield for Initial Shield Location

Figure 2.1 presents a cartoon diagram of magnetic flux flow of uniform field when it encounters a cylindrical magnetic shield. The magnetic shielding basically attracts magnetic flux into the shield so to reduce flux density inside the shield. There is always singularity point when external flux is in the orthogonal direction of the shield surface, which means the shield will always be saturated at first at the point of its surface parallel to external flux inside and shield flux density is the highest at these points.

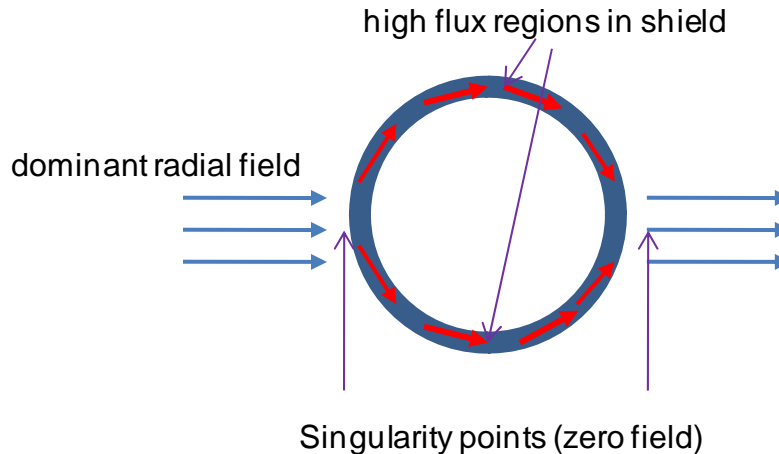

Figure 2.1 – Cartoon: Magnetization of the Shield

Figures 2.2 and 2.3 present the magnetic flux density distribution on the shield from Maxwell and OPERA models. The main 3D effects observed are that 1) Due to a vertical fringe field the magnetization effect on the shield at the top is slightly bigger than that at the bottom of the shield; 2) The low field regions (singularity point in blue) on left side of shield is located higher than that on the right side of shield; 3) The hole in the shield for the pump duct pipe (10.5 inch from bottom of shield) will slightly perturb flux around the hole but no overall large impact on the flux inside the shield.

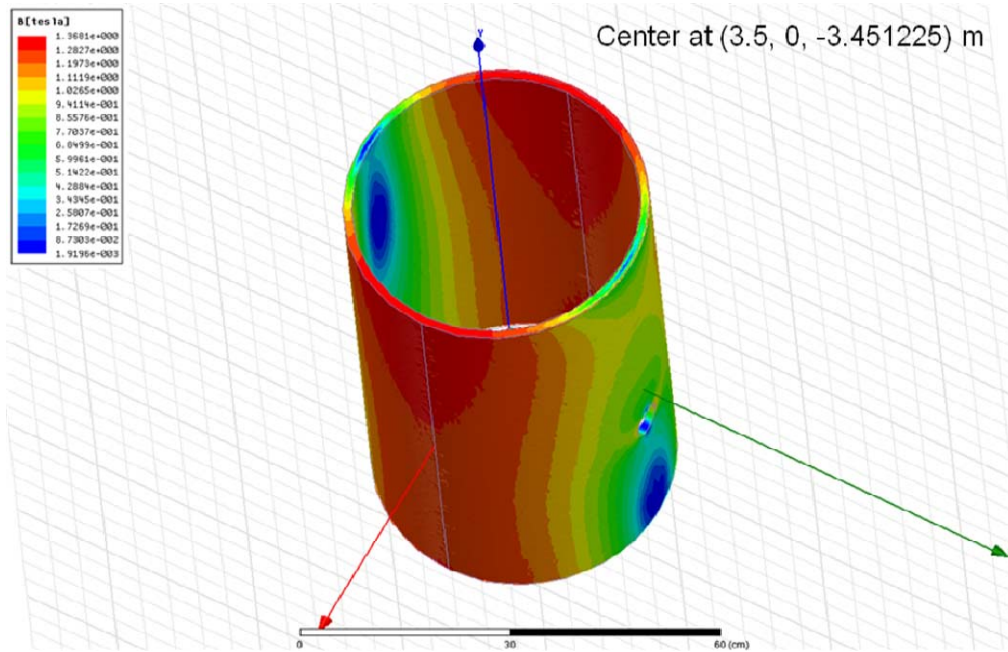

Figure 2.2 – Maxwell 3D: Magnetic Flux Density Distribution on the Shield

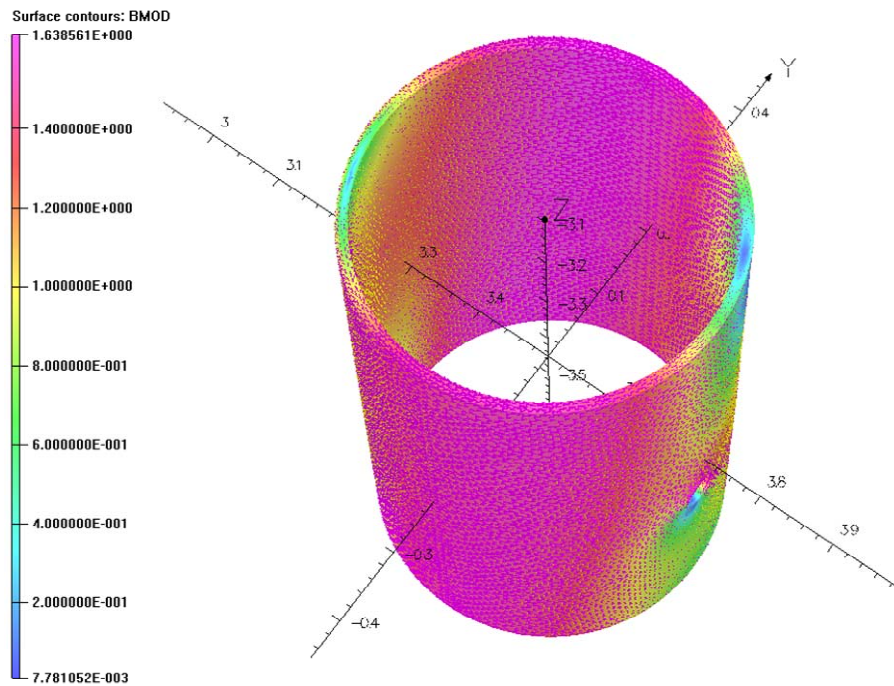

Figure 2.3 – OPERA 3D: Flux Density Distribution on the Shield with B Field Vector

Unlike Maxwell 3d results, the maximum magnetization region (red or pink) on the shield from OPERA 3d is not exactly normal to the toroidal direction (y direction). This should be the impact of the 145 gauss toroidal fringe field, which is calculated more accurately in OPERA using Biot-Savart law than that in Maxwell using finite element with a finite air boundary.

## 2.2 Forces and Torques on the Shield for Initial Shield Location

The Lorentz forces and torques due to magnetization of the shield are extracted from the postprocessor of OPERA 3d and the results are listed in Table 1. The total net force is below 50 lb, relatively very small to cause any concern.

Table 2.1 – OPERA 3D: Force and Torque on the Shield due to Magnetization

	Radial	Toroidal	Vertical	Total
Force (N)	-166.8	-31.0	86.6	190.5
Force (lb)	-33.1	-6.15	18.3	42.8
Torque (Nm)	32.0	-64.5	113.3	134.2

## 2.3 OPERA Results for Moving Shield 20 Inches Further Down

To be more convenient in supporting the shield and the turbo pump, decision is made to lower the pump and the shield 20 inches further down below the NSTX mid-plane so they are closer to the ground floor. The OPERA 3d model is adjusted to reflect the change of shield location. The fringe field at the new pump location (3.5 m, 0, -3.959 m) is reduced to ~300 G.

Figure 2.3 presents the flux density distribution on the shield, where the peak magnetic field is reduced to 1.4 T, further below the saturation value of the M-19 steel.

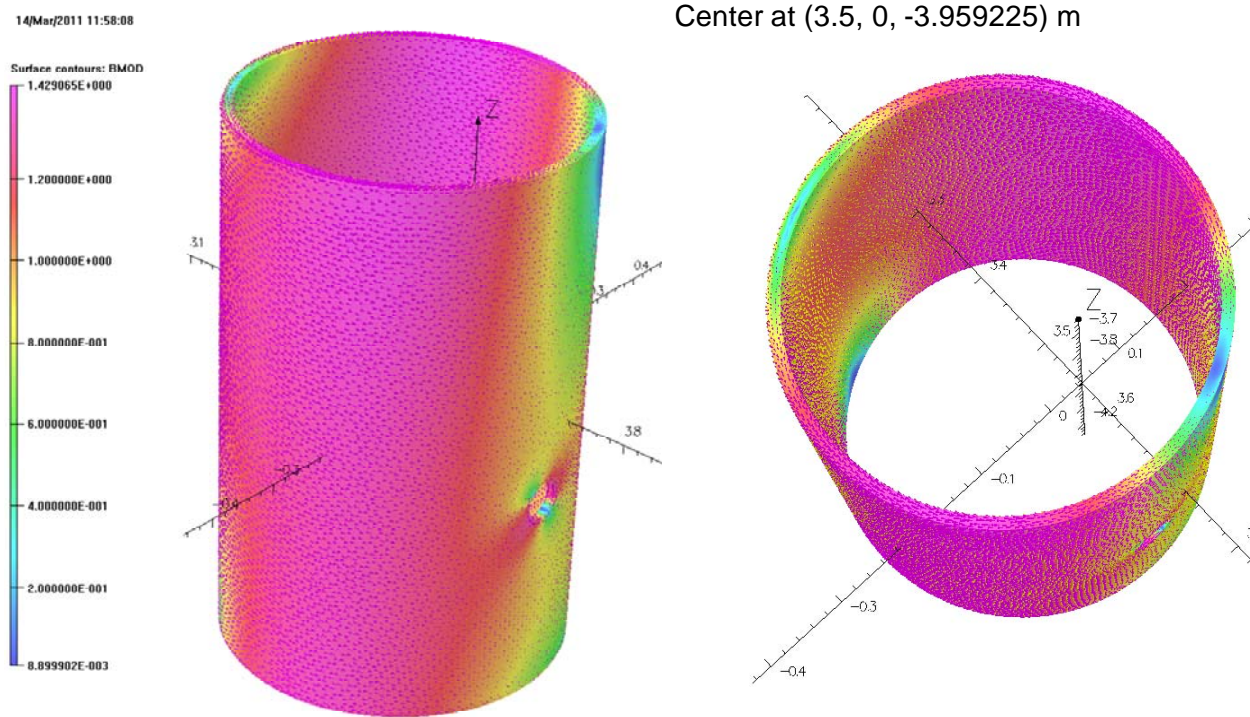

Figure 2.4 – OPERA 3D: Flux Density Distribution on the Shield Lower 20 Inches More

Figures 2.5-2.9 present the shielded total magnetic field around and inside the half-inch cylindrical shield (in radial, toroidal and vertical directions). The fields drop significantly inside the shield.

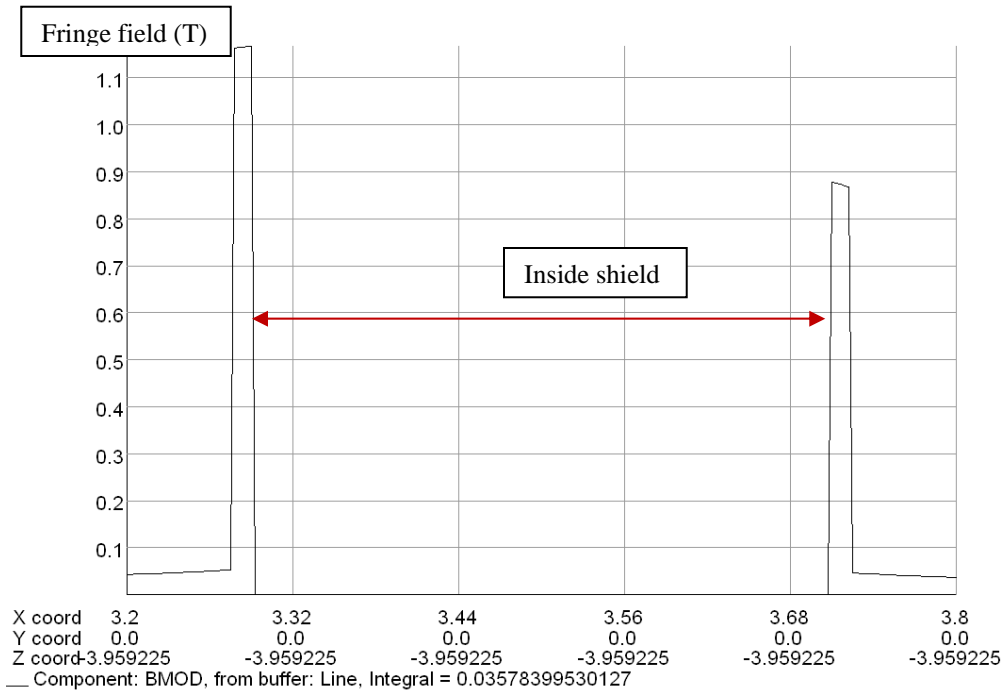

Figure 2.5 – B Field along Radial Direction in Shield Mid-Plane (Field drops significantly inside shield)

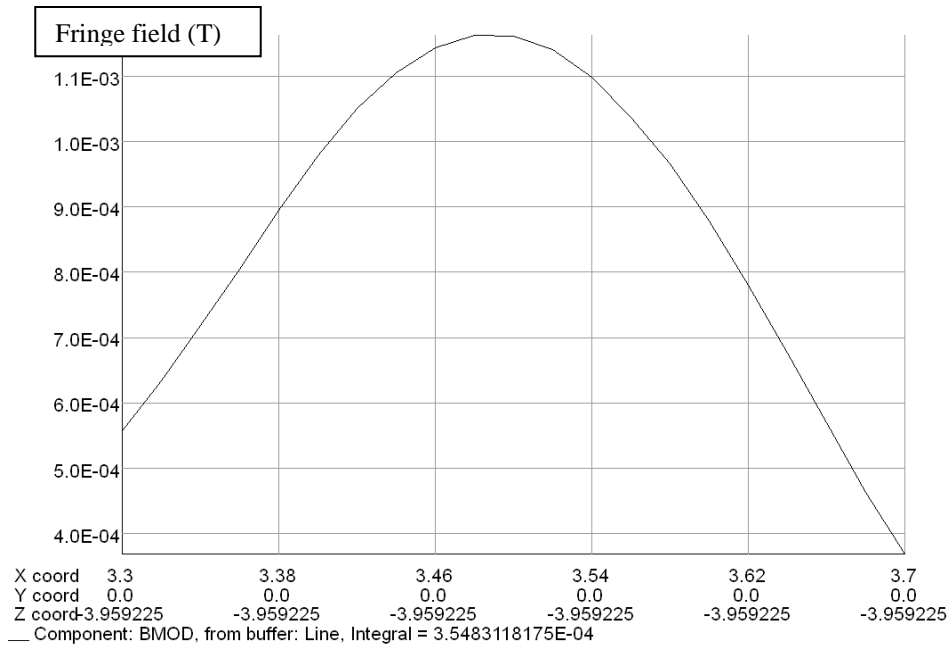

Figure 2.6 – B Field along Radial Direction in Shield Mid-Plane (inside shield)



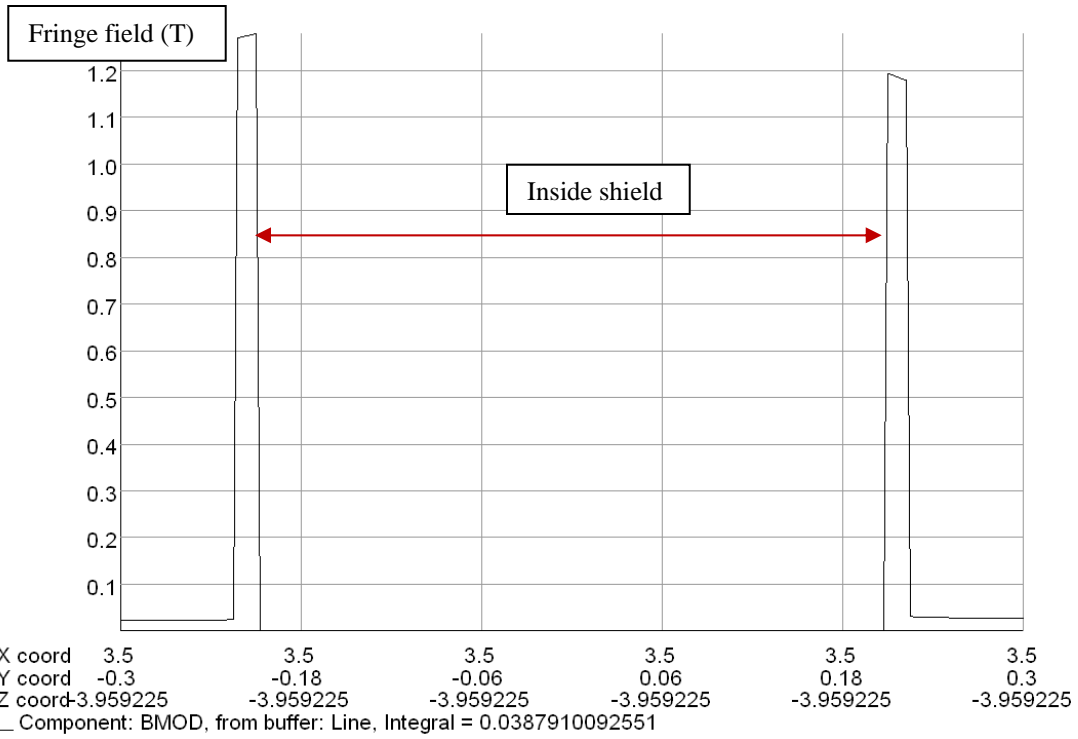

Figure 2.7 – B Field along Toroidal Direction in Shield Mid-Plane (Field drops significantly inside shield)

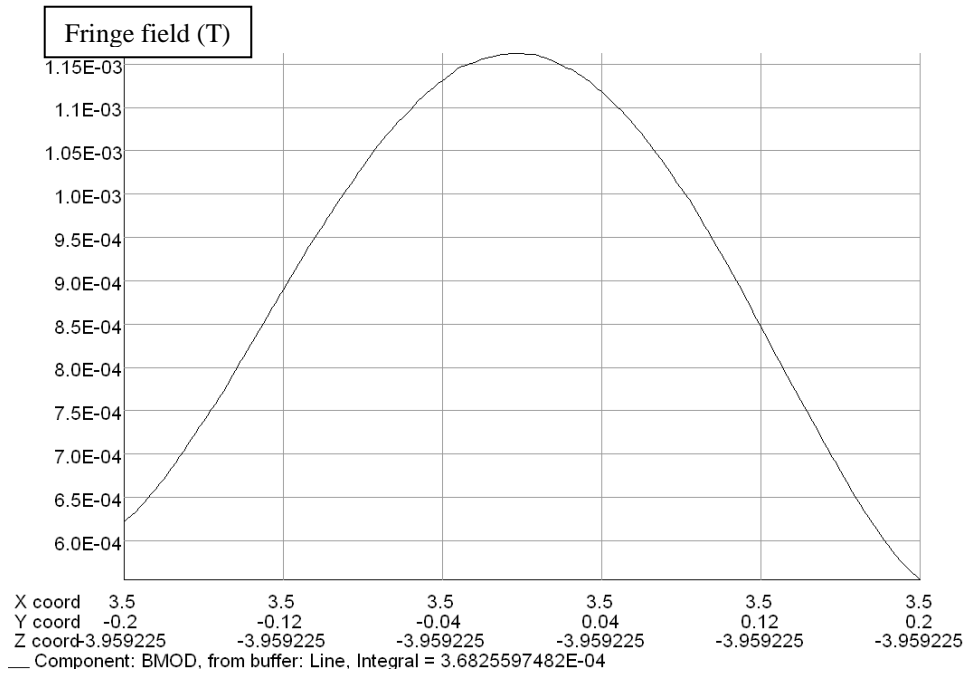

Figure 2.8 – B Field along Toroidal Direction in Shield Mid-Plane (inside shield)

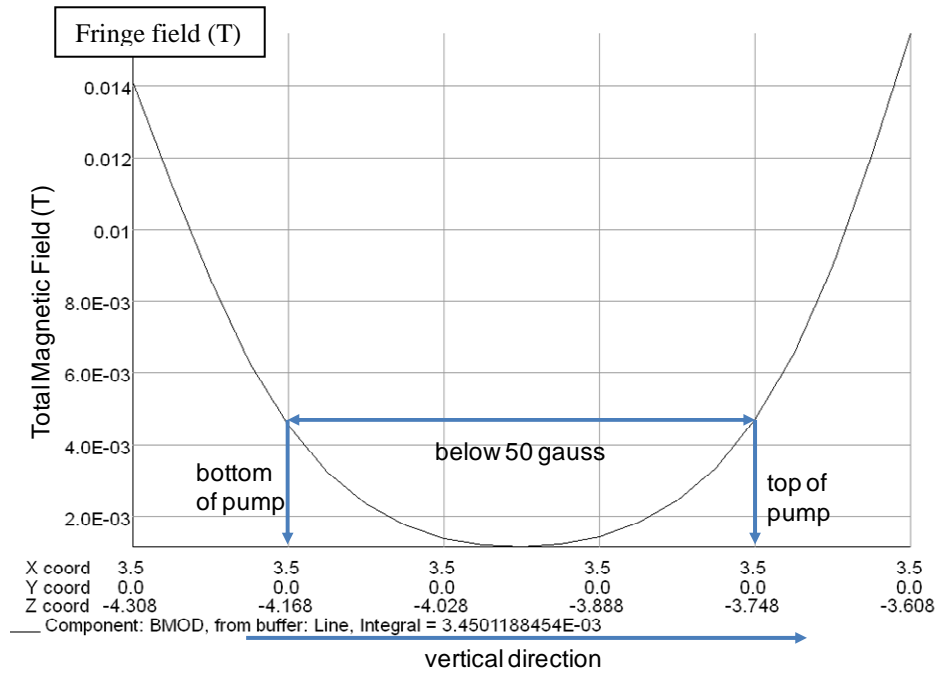

Figure 2.9 – B Field along Vertical Direction on Shield Vertical Axis

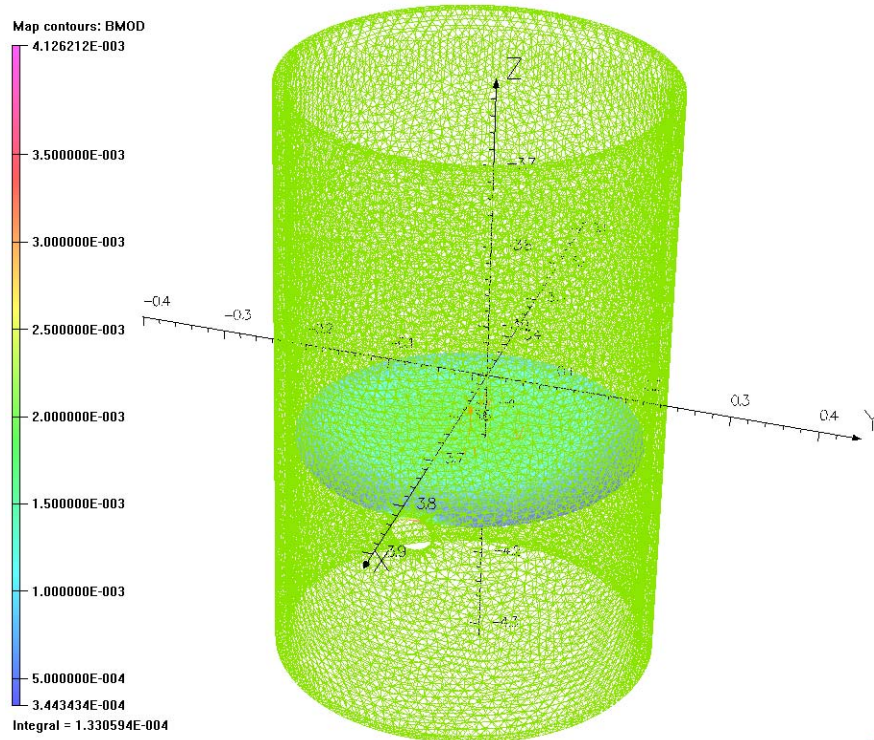

Figure 2.10 – B Field (T) around Hole inside the Shield

#### 2.4 Forces and Torques for Lowering Shield 20 Inches More below NSTX Mid-Plane

Table 2.2 presents the force and torque on shield lower 20 inches more below the NSTX mid-plane (to be closer to ground floor).

Table 2.2 – Force and Torque on the Shield (lower 20 inches more below NSTX mid-plane)

	Radial	Toroidal	Vertical	Total
Force (N)	-118.2	-31.2	70.8	141.3
Force (lb)	-26.6	-7.01	15.9	31.8
Torque (Nm)	26.2	-48.9	108.4	132.3

### 3.0 Summary and Conclusions

The fringe field within the shield is down from over 300 G to below 50 G. The force on the shield is below 50 lb and the torque is below 135 Nm.

Although the magnetic field with shielding at the mid-plane inside the shield is below 20 gauss, the shield, however, needs to be at least 12 inches longer than the pump (6 inches above the top and below the bottom of the turbo pump) for the fringe field to be within 50 gauss at the pump top and bottom of the pump.

#### References:

“Calculated Poloidal Magnetic Quantities for the May 4, 2010 Design of the NSTX CS Upgrade”, R. Woolley, PPPL Memo 13-171210-RDW-01, 17 December 2010.

“Parametric Magnetic Shielding Analysis”, L. Bryant on Magnetic Shielding Preliminary Study, PPPL Presentation, 2010.

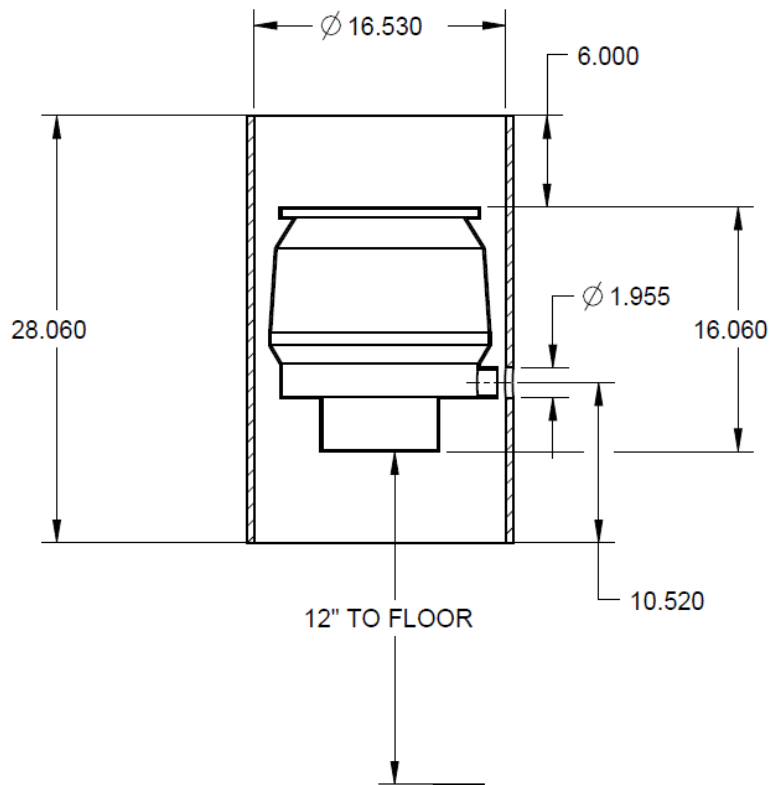

Dimension of magnetic shielding for the NSTX vacuum turbo-pump